

## C18VE

## Clamshell Bucket with Exchangeable Shells

Clamshell Bucket with exchangeable shells and vertical cylinders for excavators up to 18t / 39600 lbs operating weight – through quick and easy exchange of shells, the C18VE is ideal for different applications, for excavation operations, landscaping, trench digging, handling of logs etc. The shells can be changed in less than four minutes.

- An economic solution as only the shells have to be exchanged to suit application – bucket carrier, hydraulics and bearings are integrated into the main carrier.
- Long life is ensured due to the use of 500 HB steel in the manufacture of cutting edges.
- Reduced wear resulting from generously dimensioned bearing system with special coating.
- Excellent digging characteristics are the result of high closing forces (42 kN / 9240 lbf at an operating pressure of 35 MPa / 5040 psi).



### Clamshell Bucket C18VE

Type	Width E (mm/in)	Opening A* (mm/in)	Height C max.* (mm/in)	Length (mm/in)	Volume (litre/c.y.)	Number of teeth	Self weight (kg/lbs)	Load capacity (kg/lbs)
C18VE-33	335 / 13.19	1650 / 64.96	1595 / 62.80	1360 / 53.54	125 / 0.16	3	590 / 1298	4500 / 9900
C18VE-40	400 / 15.75	1650 / 64.96	1595 / 62.80	1360 / 53.54	160 / 0.21	3	605 / 1331	4500 / 9900
C18VE-50	500 / 19.69	1650 / 64.96	1595 / 62.80	1360 / 53.54	200 / 0.26	5	630 / 1386	4500 / 9900
C18VE-60	600 / 23.62	1650 / 64.96	1595 / 62.80	1360 / 53.54	245 / 0.32	5	655 / 1441	4500 / 9900
C18VE-80	800 / 31.50	1650 / 64.96	1595 / 62.80	1360 / 53.54	330 / 0.43	9	705 / 1551	4500 / 9900
C18VE-100	1000 / 39.37	1650 / 64.96	1595 / 62.80	1360 / 53.54	415 / 0.54	9	755 / 1661	4500 / 9900

Package consists of: clamshell bucket, bolt-on teeth, **KINSHOFER** rotator, non-return valve and hose guard, 2 welded eyes \* incl. teeth

### KINSHOFER Rotator

Continuous rotation and two oil passages. Overload protection is ensured by pressure relief valves.

Type	Upper connection (width x pin-Ø) (mm/in)	Torque (Nm / ft.lbs)	Moment of deflection max. (Nm / ft.lbs)
KM 10 F275-60	125 x 60 / 4.92 - 2.36	1500 / 1105	14000 / 10325

### Accessories

Type	Description
KM 501 13t-25t	upper suspension without pendulum damper
KM 511 13t-25t	upper suspension with pendulum damper
SW10 cardanic	adapter for Lehnhoff grab exchange system SW/MS10 without suspension – up to 19t / 41800 lbs
SW21 cardanic	adapter for Lehnhoff grab exchange system SW/MS21 without suspension – up to 28t / 61600 lbs
	adapter for quick exchange systems from other manufacturers available
KM 680 C12VE/C18VE	scraper

### Requirements of Excavator

Operating pressure (open/close):	max. 35 MPa (350 bar) / 5040 psi
Pump capacity (open/close):	75 - 150 l/min / 19.82 - 39.63 GPM
Operating pressure (rotation):	max. 32 MPa (320 bar) / 4608 psi
Pump capacity (rotation):	20 - 50 l/min / 5.28 - 13.21 GPM

### Technical Drawings

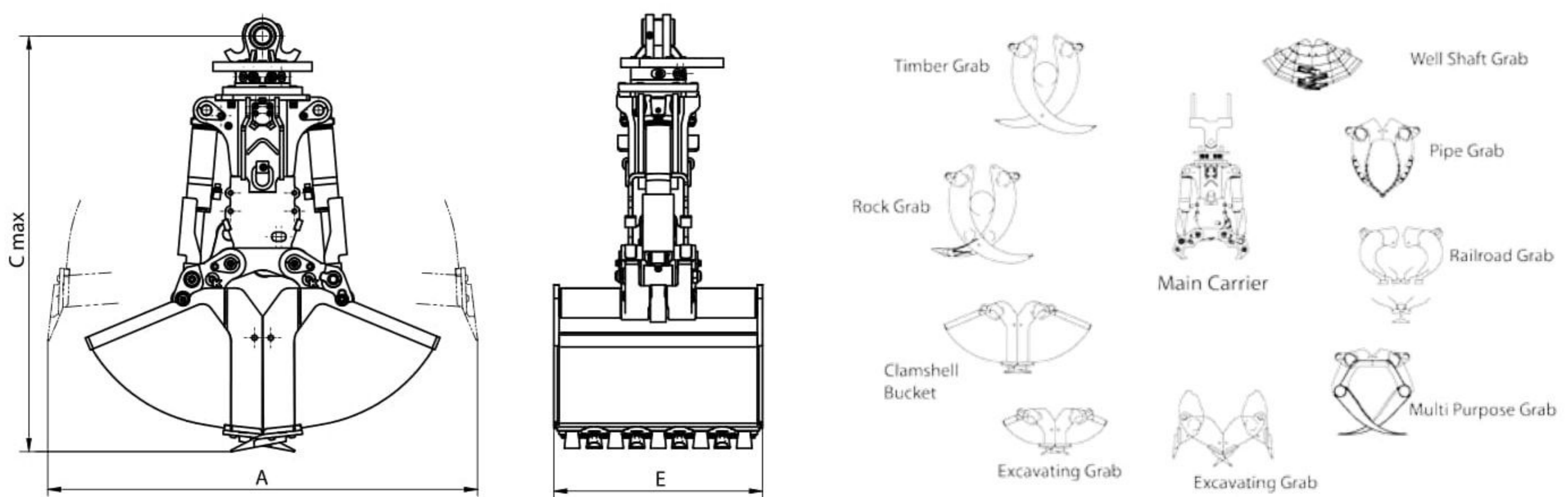





# Exchangeable Shells

# C18VE

## Exchangeable Shells for C18VE

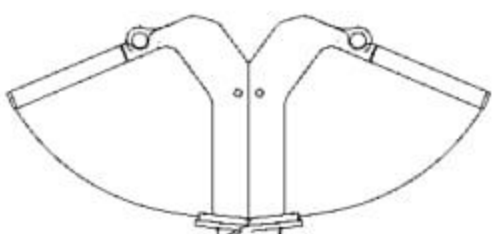
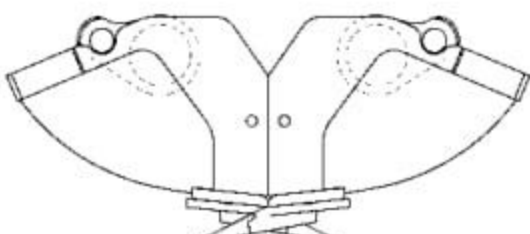
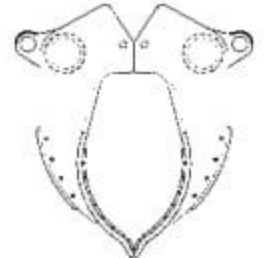
Shells are interchangeable and available in all widths. Rapid exchange with exchanging support and extraction tool.

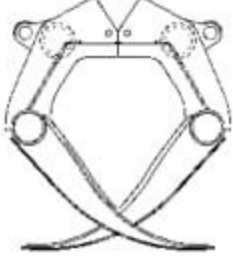
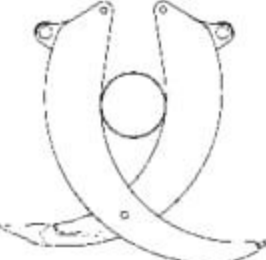
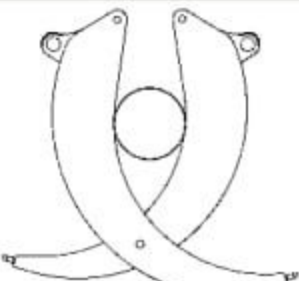
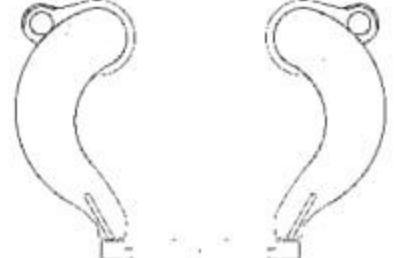
Type	Width (mm/in)	Opening (mm/in)	Height overall (mm/in)	Volume (litre/c.y.)	Number of teeth	Weight of shells (kg/lbs)	Self weight (kg/lbs)	Load capacity (kg/lbs)	Closing force (kN/lbf)
<b>Clamshell Bucket</b>									
									
<b>C18VE-33S</b>	335 / 13.19	1535 / 60.43	1595 / 62.80	125 / 0.16	3	160 / 352	545 / 1199	4500 / 9900	42 / 9240
<b>C18VE-40S</b>	400 / 15.75	1535 / 60.43	1595 / 62.80	160 / 0.21	3	180 / 396	565 / 1243	4500 / 9900	42 / 9240
<b>C18VE-50S</b>	500 / 19.69	1535 / 60.43	1595 / 62.80	200 / 0.26	5	195 / 429	580 / 1276	4500 / 9900	42 / 9240
<b>C18VE-60S</b>	600 / 23.62	1535 / 60.43	1595 / 62.80	245 / 0.32	5	225 / 495	610 / 1342	4500 / 9900	42 / 9240
<b>C18VE-80S</b>	800 / 31.50	1535 / 60.43	1595 / 62.80	330 / 0.43	9	275 / 605	660 / 1452	4500 / 9900	42 / 9240
<b>C18VE-100S</b>	1000 / 39.37	1535 / 60.43	1595 / 62.80	415 / 0.54	9	325 / 715	710 / 1562	4500 / 9900	42 / 9240
<b>Excavating Grab</b>									
									
<b>C18VE-33S EG</b>	335 / 13.19	1205 / 47.44	1430 / 56.30	90 / 0.12	3	125 / 275	510 / 1122	4500 / 9900	57 / 12540
<b>C18VE-40S EG</b>	400 / 15.75	1120 / 44.09	1385 / 54.53	55 / 0.07	3	130 / 407	515 / 1133	4500 / 9900	60 / 13200
<b>C18VE-80S EG</b>	800 / 31.50	820 / 32.28	1380 / 54.33	100 / 0.13	9	185 / 407	570 / 1254	4500 / 9900	69 / 15180
<b>Pipe Grab</b>									
									
<b>C18VE-83S PG</b>	830 / 32.68	Ø100-600 / 3.94-23.62	1625 / 63.98	-	-	295 / 649*	680 / 1496*	4500 / 9900	41 / 9020
									*: incl. support
<b>Well Shaft Grab</b>									
									
<b>C18VE-97S WSG</b>	Ø970 / 38.19	970 / 38.19	1410 / 55.51	110 / 0.14	5	170 / 374	555 / 1221	4500 / 9900	65 / 14300
Please note: larger grabs are available on request									
<b>Multi Purpose Grab</b>									
									
<b>A18VE-95S</b>	955 / 37.60	1830 / 72.05	1685 / 66.34	400 / 0.52	-	340 / 748	725 / 1595	4500 / 9900	41 / 9020
<b>A18VE-122S</b>	1220 / 48.03	1835 / 72.24	1725 / 67.91	600 / 0.78	-	275 / 605	660 / 1452	4500 / 9900	32 / 7040
<b>Rock Grab</b>									
									
<b>R18VE-49S</b>	490 / 19.29	1850 / 72.83	1820 / 71.65	0,50 m <sup>2</sup> / 0.33 cords	-	195 / 429	580 / 1276	4500 / 9900	33 / 7260
<b>Timber Grab</b>									
									
<b>T18VE-49S-0,5</b>	490 / 19.29	1830 / 72.05	1825 / 71.85	0,50 m <sup>2</sup> / 0.33 cords	-	200 / 440	585 / 1287	4500 / 9900	30 / 6600
<b>T18VE-49S-0,6</b>	490 / 19.29	1975 / 77.76	1905 / 75.00	0,60 m <sup>2</sup> / 0.40 cords	-	220 / 484	605 / 1331	4500 / 9900	33 / 7260
<b>Railroad Grab</b>									
									
<b>C18VE-50S RG</b>	500 / 19.69	1250 / 49.21	1400 / 55.12	-	-	130 / 286	515 / 1133	4500 / 9900	44 / 9680

**Package consists of:** exchangeable buckets, shell stand and pin exchange tool

**Please note:** special buckets are available on request